

ALUMINUM BLACK FRAME - 6'2" HIGH X 6' WIDE

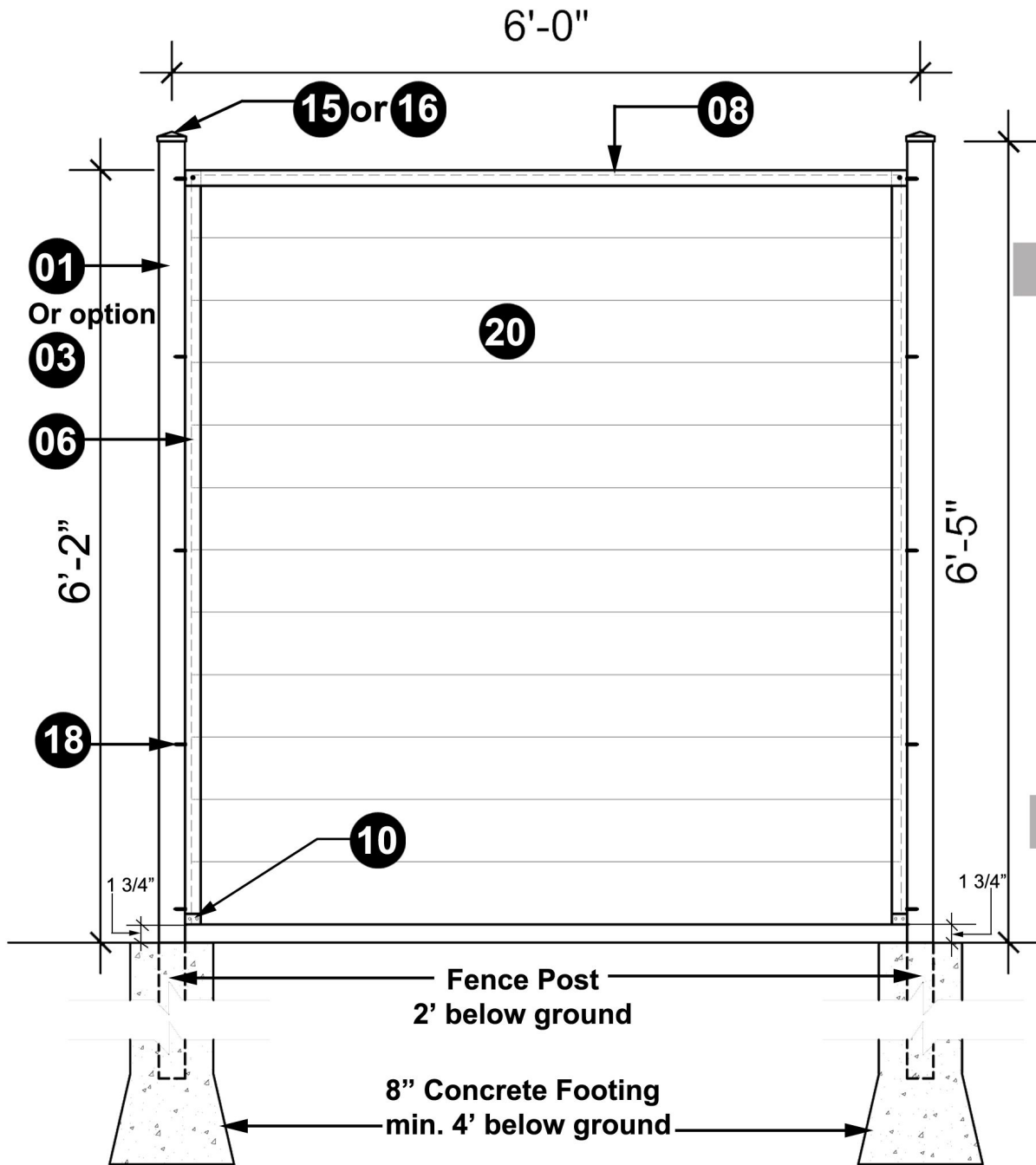

Post Options: Square Post / H-Post

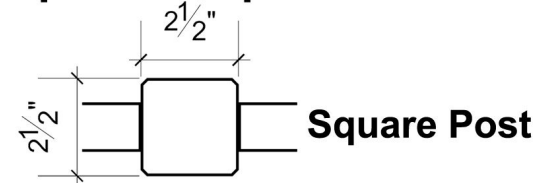

Required material per panel

Description	Code	Quantity
01 - Square Post 2.5"x2.5"x8'-5"	3248	1
06 - Side Track U Shape 73"	3250	1
08 - Top Track - U Shape 70"	3249	1
10 - Board Stopper	3258	1
15 - Pyramid Post Cap 2.5"x2.5"	3283	1
18 - Screws 1"	3282	10
19 - Plugs 3/8"	3284	0
20 - Board Fence 6"x70"		12

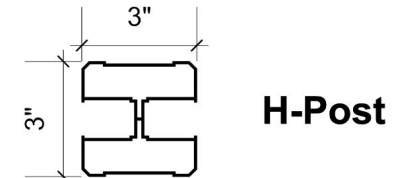

Required material per panel

Description	Code	Quantity
03 - H - Post 3"x3"x108"	3251	1
06 - Side Track U Shape 73"	3250	1
08 - Top Track - U Shape 70"	3249	1
10 - Board Stopper	3258	1
16 - Pyramid Post Cap 3"x3"	3283	1
18 - Screws 1"	3282	10
19 - Plugs 3/8"	3284	2
20 - Board Fence 6"x70"		12

*For fence height restriction, please contact
City Zoning By-Law Department

NOTE: Add an additional post for the last panel
Add an additional post for the door frame

ALUMINUM BLACK FRAME - FRAMING DESIGN OPTIONS - 6'2" HIGH X 6' WIDE

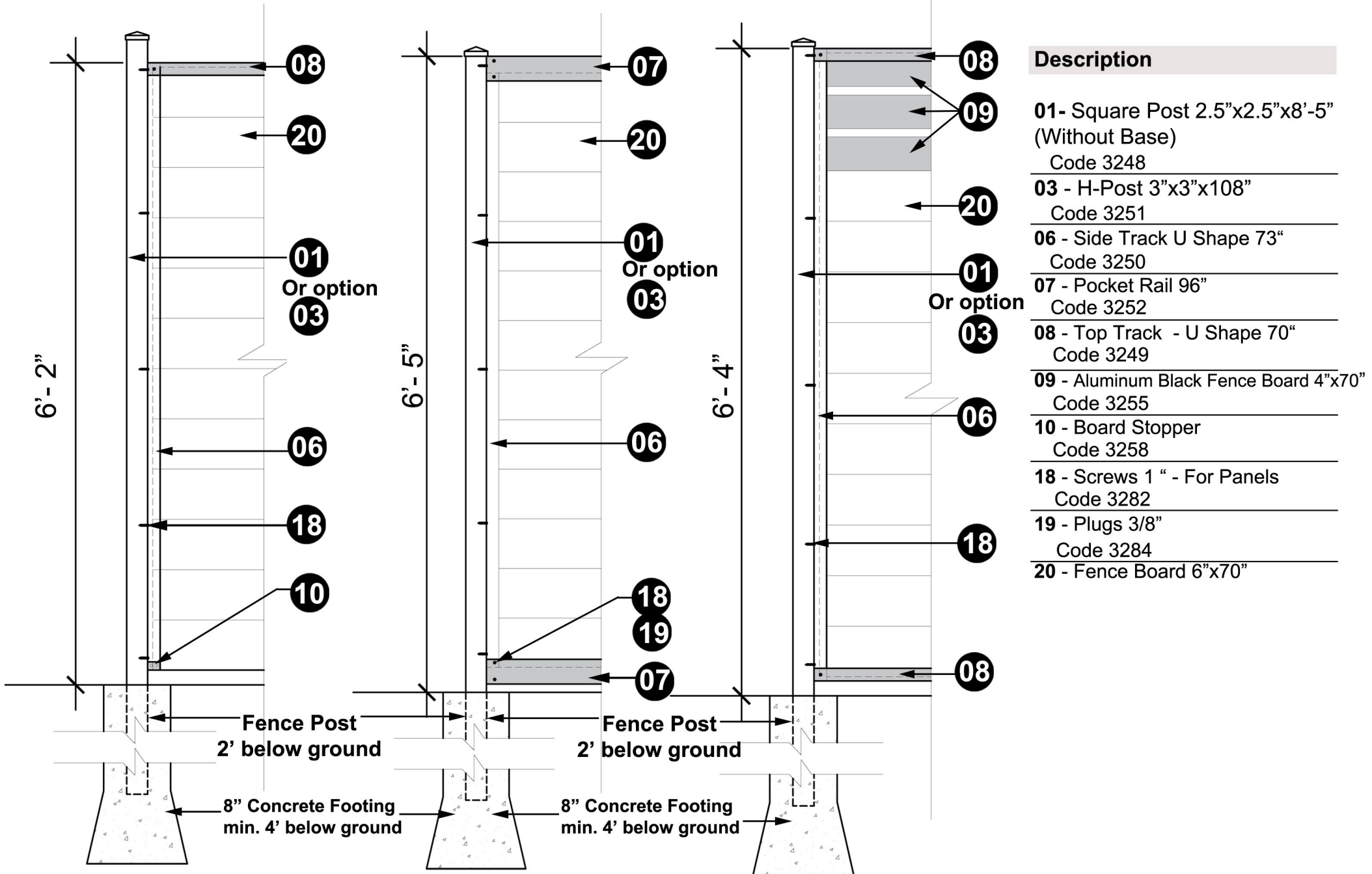

Description	
01	Square Post 2.5"x2.5"x8'-5" (Without Base) Code 3248
03	H-Post 3"x3"x108" Code 3251
06	Side Track U Shape 73" Code 3250
07	Pocket Rail 96" Code 3252
08	Top Track - U Shape 70" Code 3249
09	Aluminum Black Fence Board 4"x70" Code 3255
10	Board Stopper Code 3258
18	Screws 1" - For Panels Code 3282
19	Plugs 3/8" Code 3284
20	Fence Board 6"x70"

*For fence height restriction, please contact
City Zoning By-Law Department

ALUMINUM BLACK FRAME - GATE - 6'5" HIGH X 3' WIDE

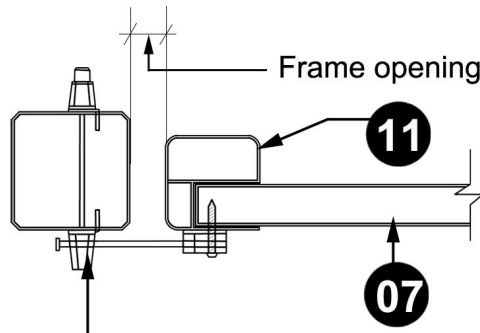
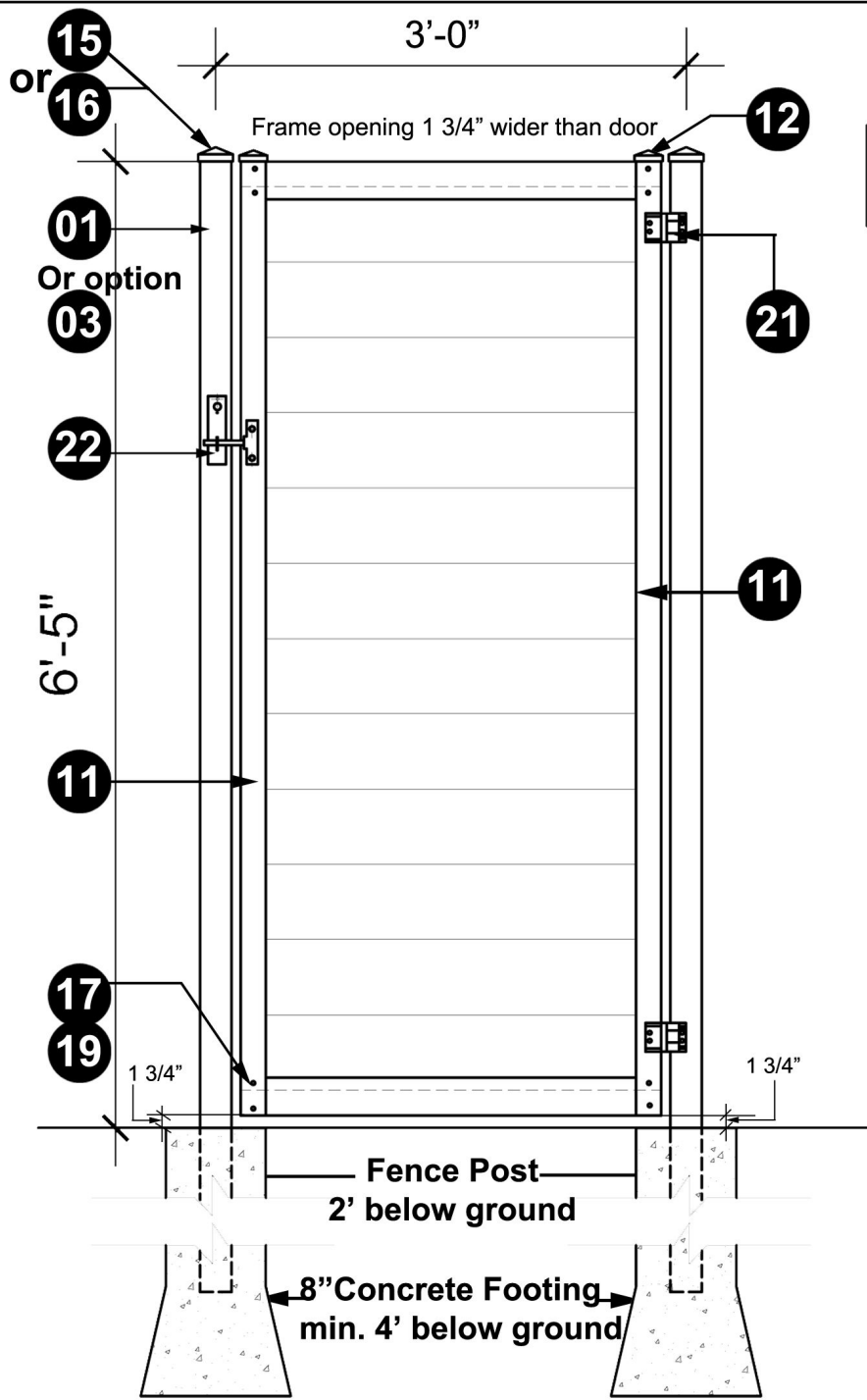

22 - Gate Latch 2 Sided

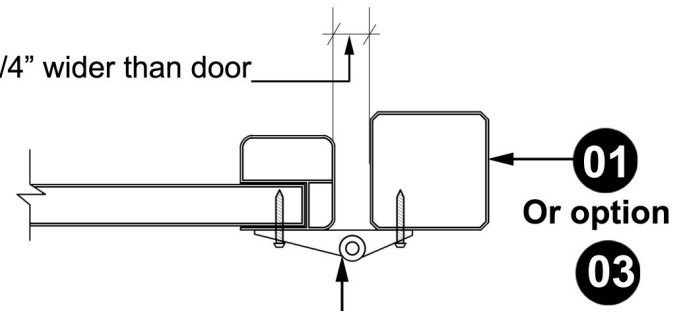











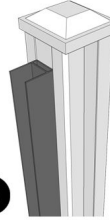
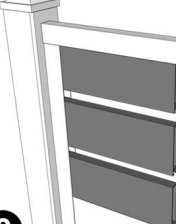
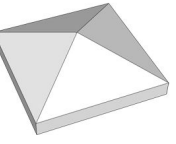

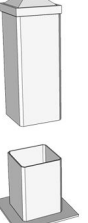
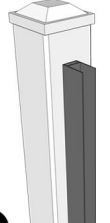
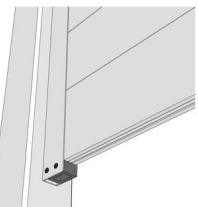

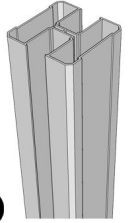
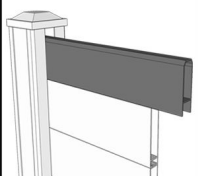
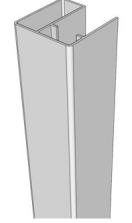
21 - Hinges
Adjustable Self Closing

Description	Code
01 - Square Post 2.5"x2.5"x8'-5" (without base)	3248
03 - H - Post 3"x3"x8'-5"	3251
07 - Pocket Rail 96"	3252
11 - Gate Side Frame Channel 144"	3253
15 - Pyramid Post Cap 2.5"x2.5"	3283
16 - Pyramid Post Cap 3"x3"	3256
12 - Gate Post Cap 2"x2"	3323
17 - Screws 1 1/2" - For Gate	3281
19 - Plugs 3/8"	3284
19 - Fence Board 6"x70"	
21 - Hinges - Adjustable Self Closing	3212
22 - Gate Latch 2 Sided	3213

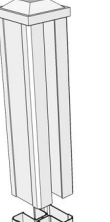
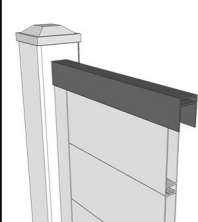
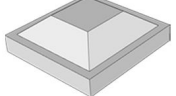
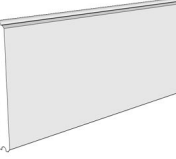
*For gate height restriction, please contact City Zoning By-Law Department

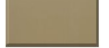
ALUMINUM BLACK FRAME - 6'2" HIGH X 6' WIDE

MATERIAL LIST - CLIENT NAME:

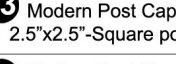
Quantity		Quantity		E-MAIL		Quantity		Quantity		TEL.	
	3248		3254		3255		3321		3212		
	3275		3250		3258		3281		3213		
	3251		3252		3253		3282		3284		3217
	3325		3249		3323						
					3283		Quantity	Quantity	Quantity	Quantity	Quantity
					3256						